

BALT5-500

INSTRUCTION MANUAL

When using Electrical Equipment, basic safety precautions should always be followed, including the following:

READ AND FOLLOW ALL SAFETY INSTRUCTIONS

1. Caution – To prevent Electrical shock, do not mate unit connector until installation is complete and A.C. power is supplied to the unit.
2. Caution – This fixture provides more than one power supply output source. To reduce the risk of electrical shock, disconnect both normal and emergency sources by turning off the A.C. branch circuit and by disconnecting the unit connector.
3. Caution – This is a sealed unit. The integral, high temperature Ni-Cad battery is not replaceable. Replace the entire unit when necessary and recycle or dispose of the Nickel-Cadmium battery properly.
4. The BALT5-500 is for use with grounded, UL listed, indoor fixtures except in heated air outlets or hazardous locations. This unit cannot be used outdoors.
5. The BALT5-500 requires an unswitched A.C. power source of either 120 or 277V. Properly cap the unused A.C. lead.
6. Do not mount near gas or electric heaters.
7. The BALT5-500 should be mounted in locations and heights where it will not readily be subjected to tampering by unauthorized personnel.
8. The BALT5-500 will cold strike and operate for 90 minutes one 2' to 4' 14-32W T5 or T8 linear lamp in the emergency mode. It is compatible with all A.C. magnetic and electronic ballasts including multiple lamp ballasts.
9. The use of accessory equipment not recommended by the manufacturer may cause an unsafe condition. Do not use this equipment for other than its intended use.
10. Install in accordance with the National Electrical Code and local regulations. Installation and servicing should be performed by qualified personnel.

SAVE THESE INSTRUCTIONS!



CAUTION :Contains nickel-cadmium rechargeable battery. Must be recycled or disposed of properly.



INSTALLATION INSTRUCTIONS

INSTALLATION

Caution – Before installing, turn off the main circuit breaker to avoid any possible shock. Also make sure that the inverter connector is disconnected.

1. Mounting the BALT5-500: Remove the ballast channel cover. Mount the BALT5-500 in the ballast channel at least ½" away from the A.C. ballast(s). When battery packs are remote mounted, the remote distance can not exceed ½ of the distance from ballast to lamp specified by the A.C. ballast manufacturer. For example, if the A.C. ballast manufacturer recommends no more than 25' remote distance, then the battery pack should not exceed 12 ½'. Under no circumstances should the battery pack exceed a distance of 50' from the lamp.
2. Wiring: Refer to the wiring diagrams on the back page for the appropriate wiring of lamp(s) and ballast. Install in accordance with the National Electrical Code and local regulations. For additional wiring diagrams consult Customer Service.
3. Installing the LED COMBO SWITCH:

Linear Fixture – Select a convenient location on the fixture so that the LED COMBO SWITCH can be seen after installation. Allow for proper clearance inside the fixture and drill or punch a ½" hole. Remove the nut from the LED COMBO SWITCH. Push the switch housing into the ½" hole and secure with the nut. Connect the LED wires from the unit to the LED COMBO SWITCH (Red to Red, White/Red to White). Refer to figure 1.

Recessed Troffer Fixture – Select a convenient location with proper clearance in the ballast cover and drill or punch a 7/8" bushing into the hole. Push the plastic tube through the bushing. Route the leads of the LED COMBO SWITCH through the plastic tube. Connect the LED wires from the unit to the switch (Red to Red, White/Red to White). Push the entire assembly back into the tube until the lens collar rests against the plastic tube. The plastic tube should be adjusted so that the LED COMBO SWITCH is within ¼" of the fixture lens. The switch must be visible after installation. Refer to figure 2.

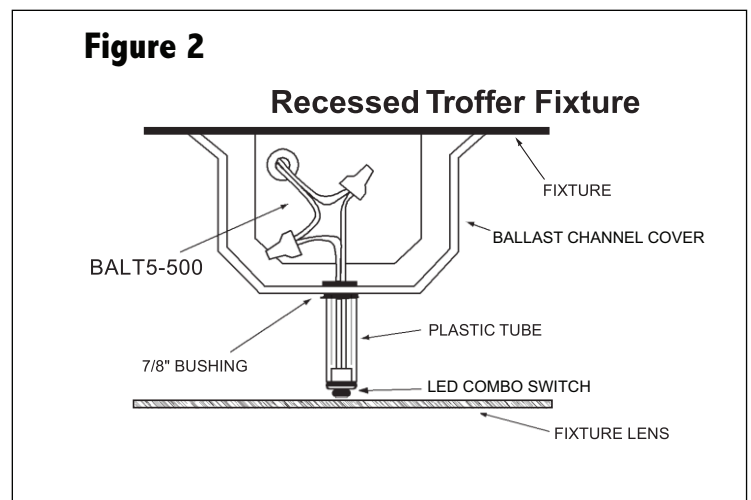
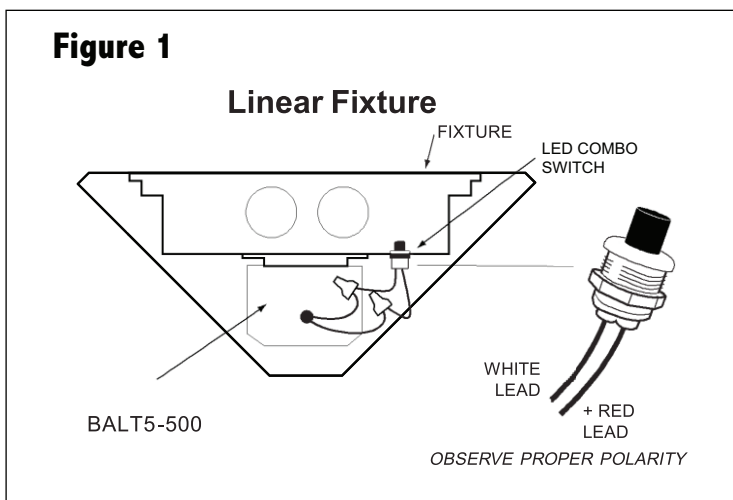

4. Power Supply: The BALT5-500 and A.C. ballast must be on the same branch circuit. It requires an unswitched A.C. power source of either 120 or 277V. Select the proper voltage lead and cap the unused lead. When the BALT5-500 is used with a switched fixture, the A.C. input to the emergency ballast must be connected ahead of the fixture switch. Refer to the figure below for switched and unswitched fixture wiring diagrams.

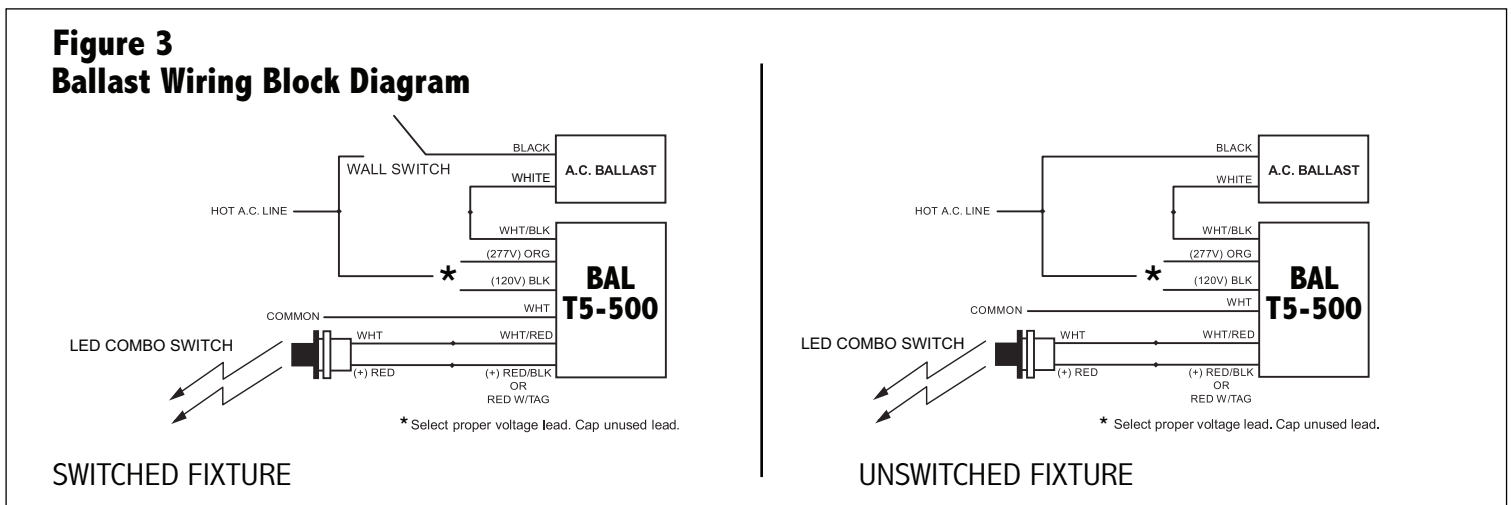

INSTALLATION INSTRUCTIONS, continued.

- Labels: Attach the appropriate labels adjacent to the LED COMBO SWITCH. The 'Caution' and the Re-lamping labels must be on the fixture in a readily visible location to anyone attempting to service the fixture.
- When Installation of the ballast is complete, switch the A.C. power on and join the BALT5-500 unit inverter connector.

OPERATION

Normal Mode – When A.C. power is present, the A.C. ballast operates the fluorescent lamp(s) as intended. The BALT5-500 is in the standby charging mode. The LED COMBO SWITCH will be lit providing a visual indication that the battery is being charged.

Emergency Mode – When A.C. power fails, the LED COMBO SWITCH senses the A.C. power failure and automatically switches to the Emergency mode. One lamp is illuminated, at reduced output, for a minimum of 90 minutes. When the A.C. power is restored, the BALT5-500 switches the system back to the Normal mode and resumes battery charging.

GENERAL INSTRUCTIONS

The BALT5-500 can be used with most 2'-4' lamps. Refer to the chart below for the type of lamp(s) operated and the number of lamps to be operated in emergency mode.

OPTION	LAMP TYPE	EMERGENCY OPERATION	VIOLET LEADS
1	2ft. T5-T12 Single, Bi-Pin	One Lamp	Connected
2	4ft. T5(28W) T8-T12 Single, Bi-Pin	One Lamp	Disconnected

The 6'' violet leads provide the lamp selection option. The unit is shipped from the factory with the leads disconnected and capped.

TESTING AND MAINTENANCE

Pushing the red lens on the LED COMBO SWITCH turns off the light (on the switch itself) and forces the unit into emergency mode, interrupting power to the designated A.C. ballast. The emergency lamp is now being lit by the BALT5-500 ballast. After releasing the LED COMBO SWITCH, the fixture returns to normal operation after a momentary delay. To simulate a 'BLACK OUT' use the circuit breaker to turn off A.C. power.

Allow the unit to charge approximately 1 hour, and then press the switch to conduct a short discharge test. The ballast needs to be charged for at least 24 hrs before conducting a one hour test.

The BALT5-500 is a maintenance-free unit, however, periodic inspection and testing is required. Per NFPA 101 and Life Safety Codes, a monthly and annual inspection needs to be done on the ballast. Servicing should always be performed by qualified personnel. Written records of the testing shall be kept by the owner for inspection by the authority having jurisdiction.

Monthly – Insure that the LED COMBO SWITCH is illuminated. Conduct a 30-second discharge test by depressing the switch. One lamp should operate at reduced output.

Annually – Insure that the LED COMBO SWITCH is illuminated. Conduct a full 1 ½ hr discharge test. The unit should operate as intended for the duration of the test.



CAUTION :Contains nickel-cadmium rechargeable battery. Must be recycled or disposed of properly.



TYPICAL WIRING DIAGRAMS

For wiring diagrams of ballasts not shown, consult our Customer Service.

1. ONE LAMP RAPID START BALLAST

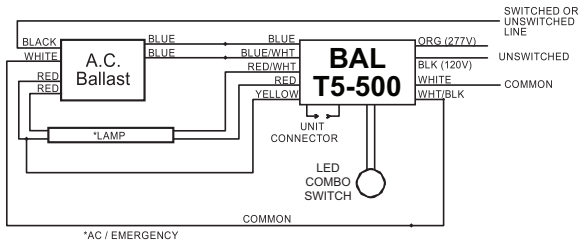

6. FOUR LAMP RAPID START BALLAST

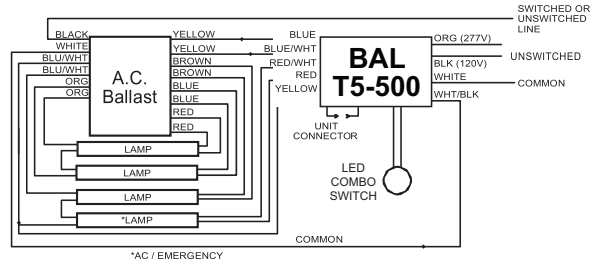

2. TWO LAMP RAPID START BALLAST (type A)

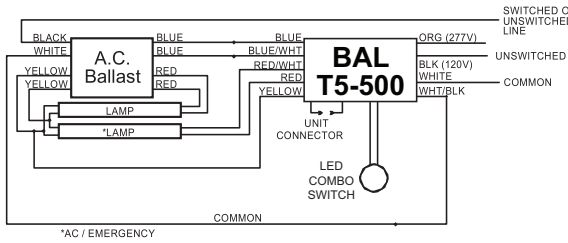

7. ONE LAMP INSTANT START BALLAST

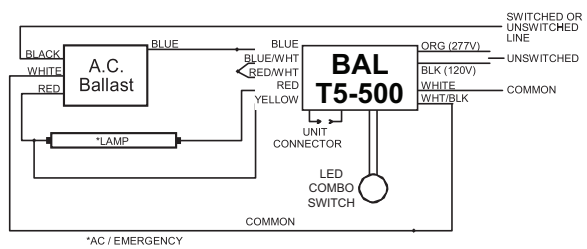

3. TWO LAMP RAPID START BALLAST (type B)

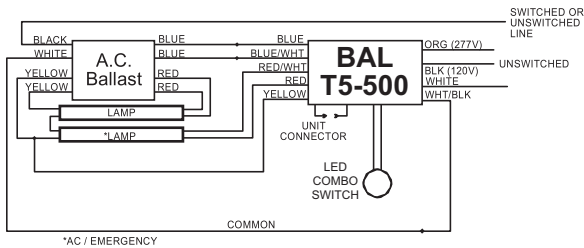

8. TWO LAMP INSTANT START BALLAST

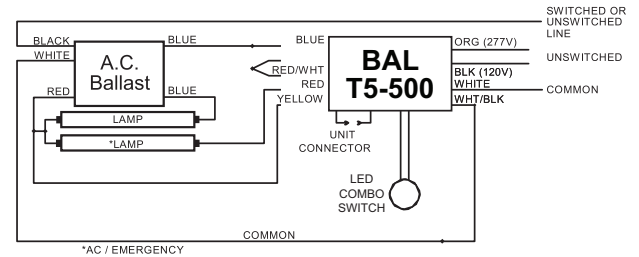

4. THREE LAMP RAPID START BALLAST (type A)

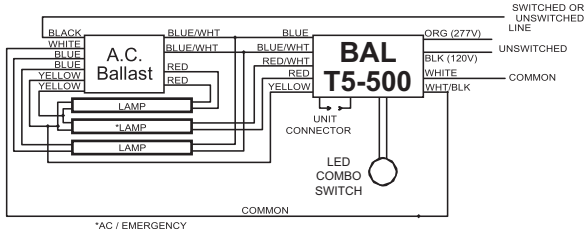

9. THREE LAMP INSTANT START BALLAST

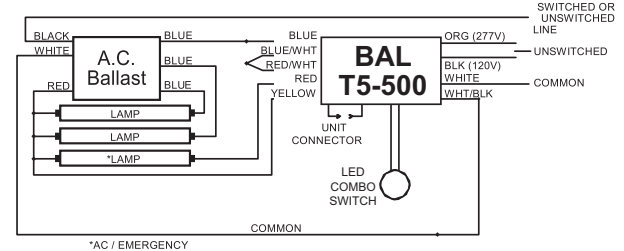

5. THREE LAMP RAPID START BALLAST (type B)

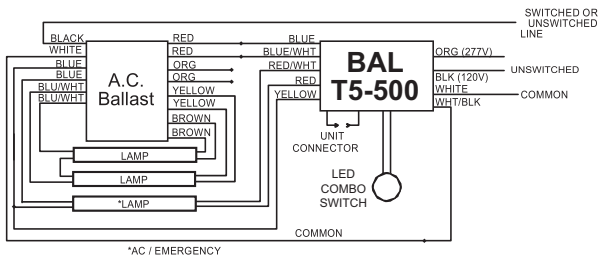

10. FOUR LAMP INSTANT START BALLAST

